Simulation Model of a Helical Gear Pump for the Evaluation of the Filling Capability

Alessandro Corvaglia¹, Massimo Rundo^{1,*}, Sara Bonati², Manuel Rigosi²

¹ *Department of Energy, Politecnico di Torino, 10129 Turin, Italy*

² *Casappa S.p.A., 43044 Lemignano di Collecchio, Italy*

*Corresponding author: massimo.rundo@polito.it

Abstract.

In this paper, a computational fluid dynamics model of a helical gear pump developed in SimericsMP+ is presented. The aim of the study is the analysis of the phenomena occurring in the suction side in conditions of incomplete filling at high velocity. The model was validated by measuring the delivered flow rate as function of the inlet pressure for different angular speeds. The experimental tests have demonstrated the capability of the model to detect with a good accuracy the operating conditions for which the delivered flow rate starts to decrease due to the partial filling of the inter-teeth chambers. Based on this study, the model seems accurate enough to be used as design tool for optimizing the pump in order to improve the filling capability.

Keywords. helical gear pump, incomplete filling, CFD, SimericsMP+.

1. INTRODUCTION

A current trend in the field of hydraulic power units is the control of the flow rate through variable speed electric prime movers driving a fixed displacement pump. In particular, the electro-hydrostatic actuators (EHA), initially developed for aeronautic applications, are mature enough to substitute the centralized hydraulic circuit in many off-road vehicles [1]. For instance, in the field of earth moving machines, many different layouts have been analyzed for achieving a fuel saving [2], including the use of individual electro-hydraulic drives for the main actuators [3]. The gear pumps are the most suitable units for such applications. The internal gear machines (crescent pumps) have the advantage that, at equal geometry of the driver gear, the kinematic flow ripple is almost an order of magnitude smaller than in an external gear pump [4]. Such a favorable characteristic leads to a lower noise, although in this aspect some technical improvements can be implemented also in the external gear units [5]. However external gear machines are the most used due to the higher maximum working pressure and the lower manufacturing cost [6]. In this context, helical gear type is more promising, being quieter than the corresponding one with straight teeth (spur gear).

Several studies have been conducted for developing simulation models of external gear pumps. Recent topics are the accurate evaluation of the mechanical-hydraulic efficiency [7, 8] and of the gears' micromotion [9]. However, the application with variable speed electric motors requires the increment of the maximum operating velocity, which can lead to incomplete filling and cavitation. The most evident effect is a saturation of the delivered flow rate with the increment of the angular speed. The phenomenon occurs when the pressure difference between the suction port and the rotating inter-teeth spaces is not enough for accelerating the fluid up to a proper velocity. The consequence is that the fluid has not enough time to completely fill the inter-teeth vanes before they leave the suction side. Such a working condition leads to two main problems: a significant decrease of the volumetric efficiency and a huge increment of the pressure ripple due to the sudden back flow when the partially filled inter-teeth chambers connect to the delivery volume. The latter problem is also responsible of an abnormal increase of the noise. Moreover, the implosion of the gaseous bubbles also generates erosion damage during time. The usual way of avoiding the incomplete filling consists in boosting the pump, but such a solution is not always feasible. All these problems are well known in the aeronautic field where the increment of the power-to-weight ratio needs the use of small displacement pumps, but with an extreme operating speed [10].

In this context, it is particularly important to develop a simulation model able to predict the filling capability in conditions of high speed, so that it can be used for the pump optimization. The phenomenon of the incomplete filling can be reproduced even with a 0D or 1D simulation model [11]. Moreover, a model tuned on experimental flow rate can reproduce correctly the characteristic huge pressure ripple generated by the intense backflow when the partially filled chambers connect to the delivery volume. However, a lumped parameter model is able to catch the influence of a geometric parameter on the pressure drop in the suction side only in an approximate way. The quantitative predictivity of the maximum flow rate can be achieved only with a CFD model, since the real 3D geometry, such as the spatial orientation of the chambers and the shape of the suction duct, must be considered without simplifications.

Some studies on the influence of the geometric parameters on the filling capability have been carried out using SimericsMP+[®] for gerotor [12] and vane pumps [13]. It has been demonstrated that the model is able to evaluate the beneficial or detrimental influence of a specific geometric modification. The main analyzed parameters were the number of chambers, the radius, and the axial thickness of the rotors. More recently, the capability of the software to predict the suction pressure at which the incomplete filling starts has been demonstrated for a straight teeth external gear pump [14].

Based on the best knowledge, simulation studies on the incomplete filling of helical gear pumps are not present in the open literature. In the present study, a CFD model of a high-speed pump prototype visible in Fig. 1 is described and validated experimentally with good results. The two gears are integral with the shaft and housed in the pump casing. The shafts are supported by journal bearings mounted in the balance plates. The aim of the balance plates is twofold: to compensate the axial gaps and to manage the connection of the trapped volume in the meshing region. The balance plates are also provided with peripheral channels for transferring the delivery pressure back in a number of inter-teeth volumes.

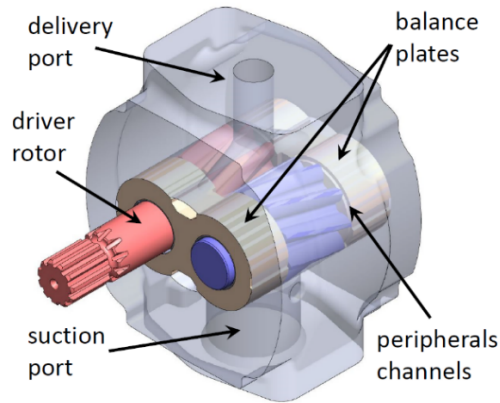

Fig. 1. 3D drawing of the helical gear pump

2. SIMULATION MODEL

2.1. Model structure

The model of the pump was developed at the Politecnico di Torino with the software SimericsMP+. Starting from the surfaces of the fluid domain, different volumes were identified, as shown in Fig. 2.

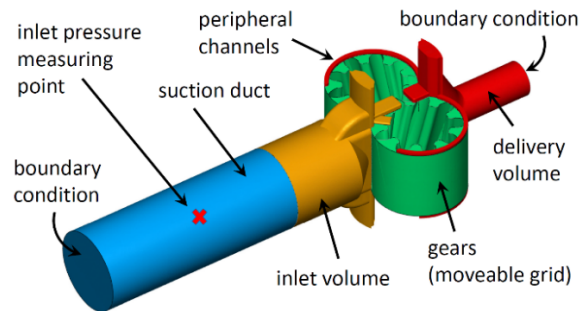

Fig. 2. Subdivision of the volumes with the location of the inlet pressure transducer

The inlet and delivery ducts are fixed; they also include the peripheral channels and the machining on the balance plates, while the green volumes rotate around the gears' axis. In addition, a fixed cylindrical volume was added for simulating the upstream portion of the inlet pipe. The position of the measuring point of the inlet pressure is the same as on the test rig. For the choice of the distance of the inlet boundary condition from the measuring point, it was verified that a longer length of the inlet pipe had no influence on the results, but only on the computational time. Despite the aim of the study is to correctly simulate the phenomena occurring at high speed in the suction side with low delivery pressure, a micro-shift of the gears along the horizontal and vertical axes was applied for obtaining a more reasonable value of the fluid leakages. In particular, to consider the mean direction of the

force acting on the rotors, the axes of the gears were shifted towards the suction side and the distance between the axes was reduced. The axial clearances were neglected because the gaps are compensated by the balance plates. Since it is not possible to have contact between the gears for the continuity of the mesh, a gap was left between the flanks of the teeth. However, since the study was performed at low delivery pressure, this additional leakage does not significantly affect the delivered flow rate of the pump.

The mesh of the rotating volumes was built with the template external gear that generates a structured hexahedral grid. During the rotation, the number of cells in the radial direction is kept constant and the mesh is compressed when a tooth of the opposite gear enters the tooth space. The outermost layer of the cells is made to slide with respect to the housing and to the grid of the opposite gear. The inlet and delivery volumes were meshed with the general mesh generator that generates an unstructured Cartesian grid with cubic elements. The mesh was refined locally in the grooves and in the peripheral channels. Finally, the grid of the inlet duct was created with a mesh generator specific for cylindrical geometries. A 3D view of the mesh is shown in Fig. 3.

For the simulation of aeration and cavitation, the transient for air release and dissolution can have an influence [15] and SimericsMP+ allows considering these transients [16]. However, the uncertainty on the amount of total air and on the values of time constants makes the use of the most detailed model questionable, therefore the model of fluid Equilibrium Dissolved Gas was chosen.

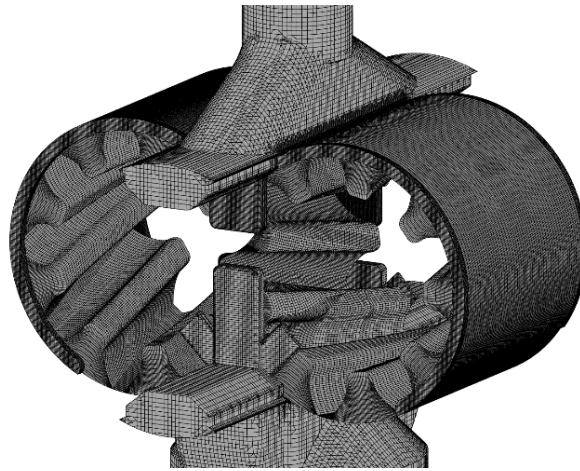

Fig. 3. View of the mesh of the variable volume chambers and of the inlet/outlet volumes.

The total volume fraction of air used in the simulation is equal to 6%. Such a percentage was selected because it was proved to be a good starting value, although obtained by tuning on a different test rig [13]. No turbulence model was applied since previous studies on fluid power pumps have demonstrated the negligible effects on the simulated results due to the high viscosity of the hydraulic oils [14, 17].

The software discretizes the governing equations with the finite volume method. In the present analysis, the first-order upwind interpolation scheme was used, while the SIMPLE-S method was employed for the pressure–velocity coupling. As boundary conditions,

pressures were imposed at the two ports (Fig. 2). Transient simulations were performed, and the moving average of the delivery flow rate calculated over a shaft revolution was monitored. The steady-state condition was considered reached when the difference between the mean flow rates calculated in two consecutive revolutions became lower than 1%. Starting from a new simulation, usually 3-4 revolutions are necessary to achieve the steady-state conditions. However, a couple of revolutions could be enough if the proper initial conditions are set, namely the final results of a previous simulation executed in a close operating point.

2.2. Model optimization

The mesh sensitivity analysis was carried out on the version of the pump with straight teeth. As far as the total number of cells is concerned, it was found that its increment from 0.5 to 1.6 million led to a variation of the calculated delivery flow rate of less than 0.5%. Hence a number of cells around 1 million is usually enough for this kind of study. However, the version with helical teeth needs a higher number of layers axially in the rotor domain. This increment is not necessary for improving accuracy, but for avoiding problems of convergence due to the interference of the gears. In fact, in order to reproduce the helical shape with good accuracy, the number of cells' layers must be high enough, otherwise an unrealistic stepped gap between the gear flanks is obtained. Based on these analyses, for each rotor 720 cells in the circumferential direction, 11 radially and 50 axially were set. It must be noticed that in a straight teeth pump 12 cells in the axial direction were instead enough. In Table 1 the detail of the number of cells used in the model is reported.

Table 1. Number of cells for each subdomain

Volume	Number of cells
2 Rotors	792.000
Delivery volume	760.143
Inlet volume	181.732
Suction duct	22.800
Total	1.756.675

In order to determine the angular step and the residual for the best trade-off between accuracy and computational time, the tests listed in Table 2 were performed. In SimericsMP+ the exponent of the residual drop is defined as the difference between the natural logarithm of the residual at the n-th iteration and maximum residual in all previous iterations from 1 to n-1. The volumetric efficiency is defined as the ratio between the calculated and the theoretical flow rates. For confidentiality reasons, the speed and delivery pressure used for such tests cannot be provided. The CPU time is expressed in hours per shaft revolution, and it was obtained on a workstation with Intel Xeon Platinum 8268 processor with 24 cores at 2.90 GHz. It can be observed that the use of a residual 0.1 leads to a significant underestimation of the volumetric efficiency, while with a residual 0.01 the reduction of the angular step does not give any improvement on the flow rate, but only increases the computational time. Therefore, the simulations were performed with an angular step of 1 degree and a residual drop of 0.01. With these settings the convergence is reached usually with 50-70 iterations.

Table 2. Influence of the angular step and of the residual

Configuration	Volumetric efficiency	CPU time (h/rev)
0.5 deg – residual 0.1	94.3 %	3.5
0.5 deg – residual 0.01	96.7 %	16.5
1 deg – residual 0.1	90.3 %	3
1 deg – residual 0.01	96.7 %	7

3. MODEL VALIDATION

The experimental tests were carried out at the Casappa SpA laboratory. The hydraulic scheme of the test rig is reported in Fig. 4. A variable speed electric motor drives two axial piston pumps Casappa MVP60. The pump labelled PU1 feeds a fixed displacement external gear motor Casappa PHM 20 that drives the pump under test. This solution allows working at a speed higher than the one that can be imposed by the electric motor. On the delivery port of the helical gear pump the only resistance is due to the filter and the flow meter F1. The pump with label PU2, along with the preloaded check valve, is used for controlling the inlet pressure of the pump under test. Since the flow rate delivered by the pump PU2 is always slightly higher than the flow rate sucked by the helical gear pump, an excess flow is continuously discharged by the check valve that imposes upstream its cracking pressure. By means of a manual restrictor R, the suction pressure can be reduced to the desired value measured by the transducer P4. The details of the transducers are listed in Table 3. The tests were performed with an ISO VG46 oil at the temperature of 50 °C.

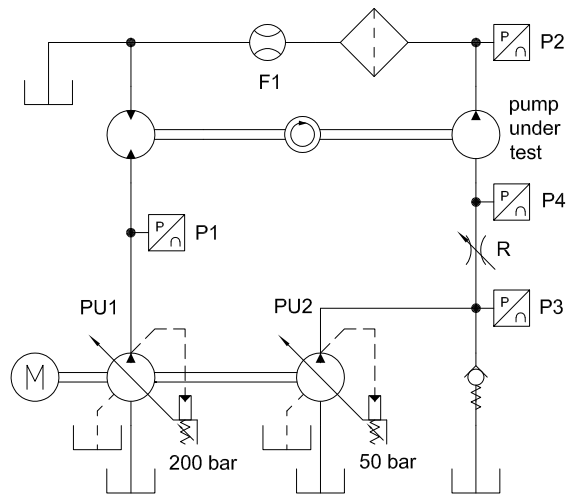

Fig. 4. Hydraulic scheme of the high-speed test rig

The test procedure consisted of imposing a value of angular speed and progressively reducing in steps the flow area of the variable restrictor R. For each value of the inlet pressure measured by the transducer P4, the flow rate was recorded. The results of the steady-state

tests at three angular speeds are reported in Fig. 5. For confidentiality reasons, the quantities have been normalized with respect to the maximum experimental values.

Table 3. Technical data of the transducers

Quantity	Transducer	Range	Accuracy
Pressures P1, P2	Trafag 8253	0÷400 bar	±0.3% F.S.
Pressures P3, P4	Trafag 8254	-1÷4 bar	±0.3% F.S.
Flow rate	VSE VS 4	1÷250 L/min	±0.3% Reading

It can be observed that for high values of the inlet pressure the delivered flow rate is insensitive to the flow area of the restrictor, while a noticeable reduction due to the incomplete filling occurs at low pressure levels. Moreover, it is evident that the inlet pressure at which the flow rate begins to decrease increases with the pump speed. Such a behavior can be explained considering that, with equal pressure measured at the inlet port, the higher speed implies a bigger energy spent by the fluid for entering the rotating chambers. The model can predict with good accuracy the critical suction pressure below which the incomplete filling occurs. Moreover, the gradual reduction of the flow rate visible at 4500 rpm in the pressure range 0.4 - 0.6 is also correctly reproduced. At 6000 rpm a slight overestimation of the flow rate in conditions of complete filling is visible. A possible reason for this discrepancy is because the micro-positioning of the gears was calibrated on the test at 3000 rpm and the same axes' position was maintained also for the other speeds. It is likely that at 6000 rpm, due to a higher load capacity of the bearings, a smaller shift towards the inlet volume occurs, leading to a higher leakage on the tips of the teeth. However, apart from this offset, the shape of the simulated curve reproduces very well the experimental trend. Fig. 6 shows a visualization of the air release in the meshing region of the suction side in operating point 1 indicated in Fig. 5. The cut-plot of the total gas volume fraction is taken in the midplane of the gears. Due to the rapid increment of the volume, a massive formation of gaseous phase is detected in the chambers of both gears at 0 degrees.

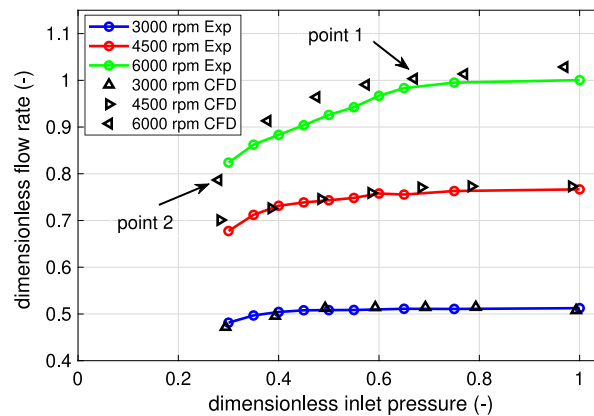

Fig. 5. Comparison between experimental and simulated normalized delivery flow rate vs. dimensionless absolute inlet pressure for three different shaft speeds

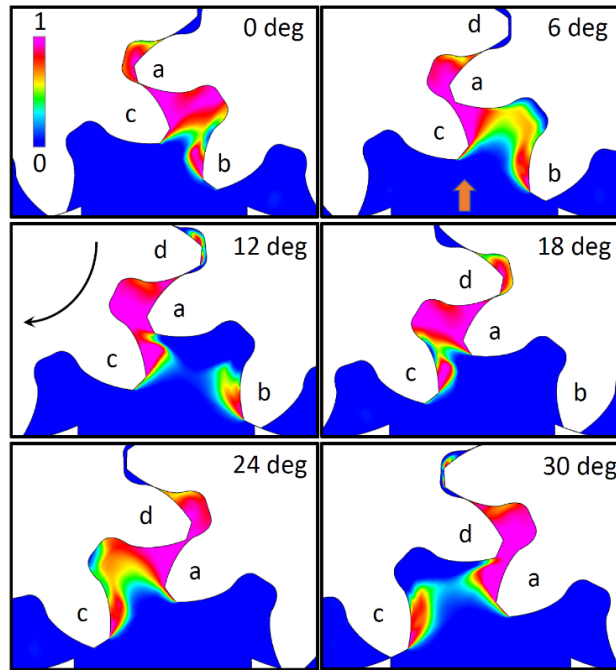

Fig. 6. Total gas volume fraction for 6 different angular positions of the gears in the operating point 1 in Fig. 5 (blue color indicates only liquid phase)

At 6 degrees the fraction of gas in the chamber between the teeth “a” and “b” of the driver gear progressively decreases for the following reasons.

- The derivative of chamber volume has become zero, since the tooth “c” has completely left the space between “a” and “b”.
- The area connection between the chamber and the suction volume has become quite large, since the distance between the tips of the teeth “b” and “c” has significantly increased.
- The chamber is favorably oriented with respect to direction of the incoming flow.

At 12 degrees the gaseous phase is only located behind the trailing flank of the tooth “b”, while at 18 degrees the filling of the chamber is complete. In a similar way the chamber between the teeth “c” and “d” of the driven gear is almost empty at 12 degrees due to the fast increment of the volume and the small flow area. The oil enters the chamber starting from the lower radius (24 degrees), where the peripheral velocity is smaller, and radially due to the favorable orientation of the chamber with respect to the inlet jet; at 30 degrees the air fraction is located only behind the tip of the tooth “c”.

In operating point 1 the delivered flow rate is very close to the maximum value, because the inlet pressure is high enough for recovering the missing oil volume in the inter-teeth spaces before they leave the suction side. Hence the local formation of gaseous phase in the meshing region has no effects on the overall behavior of the pump. On the contrary, if the

inlet pressure is further decreased the chambers remain partially empty up to the connection with the delivery volume. In Fig. 7 the gas volume fraction is shown for the case with severe incomplete filling (point 2 in Fig. 5). When the chambers are isolated, the centrifugal force pushes the liquid phase outwards, and the gas fraction is confined in the innermost part of the gears.

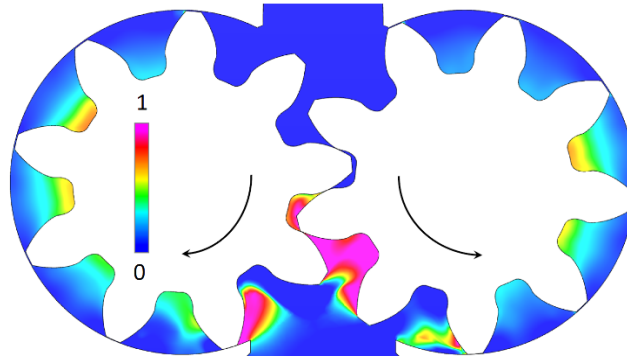

Fig. 7. Cut-plot of the total gas volume fraction in the operating point 2 in Fig. 5

In Fig. 8 the pressure distribution is shown. For confidentiality reasons the values on the color scale have been omitted. In the suction volume the lowest pressure level (dark blue) occurs in the meshing region and behind the trailing flank of the teeth, while an overpressure is detected in front of the leading flank. In the isolated chambers the pressure level remains low since the leakage on the tip of the teeth and the flow through the peripheral channels are not enough to compensate for the missing oil volume. Hence the chambers are abruptly pressurized when they are connected directly to the delivery volume. The generated backflow is the cause of the typical high pressure ripple and noise occurring in conditions of incomplete filling. Since the aim of the developed model is only the evaluation of the incomplete filling, the entire delivery line has not been simulated for limiting the computational time. Hence a reliable estimation of the pressure ripple is not possible. However, in the reference [18] the increment of the pressure pulsation in a gear machine in condition of incomplete filling can be appreciated.

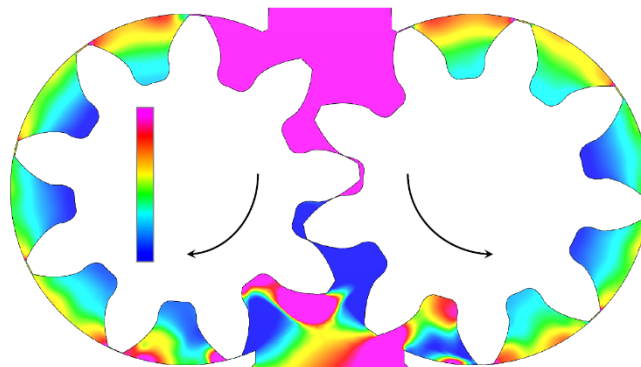

Fig. 8. Cut-plot of the pressure field in the operating point 2 in Fig. 5

4. CONCLUSIONS

The development of a fixed displacement pump for a direct connection to a variable speed electric motor represents a challenge due to the risk of incomplete filling and cavitation. The proper geometry of the casing and of the gears must be optimized in order to minimize the pressure drops in the suction side. The evaluation of the effect on the filling of a geometric modification needs a model able to consider the real 3D shape of the volumes and their relative motion. In this paper the reliability of the CFD model has been proved on a helical gear pump prototype. More specifically, the minimum suction pressure that still allows the complete filling of the chambers is estimated with good precision. Moreover, it has been verified that the limit suction pressure increases as the speed is increased. The outcomes allow being confident that the developed model can be used as design tool for optimization purposes. Possible future studies will involve the analysis of the influence of some geometrical parameters of the gears and of the suction port for extending the operating speed range of the pump.

5. REFERENCES

- [1] S. Qu, D. Fassbender, A. Vacca, E. Busquets, ‘A high-efficient solution for electro-hydraulic actuators with energy regeneration capability’, *Energy*, 216, 2021, doi: 10.1016/j.energy.2020.119291.
- [2] A. Bedotti, M. Pastori, P. Casoli, ‘Modelling and energy comparison of system layouts for a hydraulic excavator’, *Energy Procedia*, 148, pp. 26-33, 2018, doi: 10.1016/j.egypro.2018.08.015.
- [3] P. Casoli, F. Scolari, T. Minav, M. Rundo, ‘Comparative Energy Analysis of a Load Sensing System and a Zonal Hydraulics for a 9-Tonne Excavator’, *Actuators*, 9(2), 2020, doi: 10.3390/ACT9020039.
- [4] M. Rundo, ‘Theoretical flow rate in crescent pumps’, *Simul. Model. Pract. Theory*, 71, pp. 1-14, 2017, doi: 10.1016/j.simpat.2016.11.001.
- [5] G. Marinaro, E. Frosina, A. Senatore, ‘A Numerical Analysis of an Innovative Flow Ripple Reduction Method for External Gear Pumps’, *Energies*, 14(2), 2021, doi: 10.3390/en14020471.
- [6] J. Ivantysyn, M. Ivantysynova, ‘Hydrostatic pumps and motors’, *Akademia Books International*, New Delhi, 2001.
- [7] B. Zardin, E. Natali, M. Borghi, ‘Evaluation of the Hydro—Mechanical Efficiency of External Gear Pumps’, *Energies*, 12(13), 2019, doi: 10.3390/en12132468.
- [8] R. Rituraj, A. Vacca, M. Rigosi, ‘Modeling and validation of hydro-mechanical losses in pressure compensated external gear machines’, *Mech. Mach. Theory*, 161, 2021, doi: 10.1016/j.mechmachtheory.2021.104310.
- [9] X. Zhao, A. Vacca, ‘Multi-domain simulation and dynamic analysis of the 3D loading and micromotion of continuous-contact helical gear pumps’, *Mech. Syst. Signal Process.*, 163, 2022, doi: 10.1016/j.ymsp.2021.108116.
- [10] Q. Chao, Z. Xu, J. Tao, C. Liu, J. Zhai, ‘Cavitation in a high-speed aviation axial piston pump over a wide range of fluid temperatures’, *Proc. ImechE, Part A: J. Power and Energy*, 2022, 236(4), pp. 727-737, doi: 10.1177/09576509211046998.
- [11] D. Buono, F.D.S.D. Cola, A. Senatore, E. Frosina, G. Buccilli, J. Harrison, ‘Modelling Approach on a Gerotor Pump Working in Cavitation Conditions’, *Energy Procedia*, 101, pp. 701-709, 2016, doi: 10.1016/j.egypro.2016.11.089.

- [12] G. Altare, M. Rundo, 'CFD analysis of gerotor lubricating pumps at high speed: Geometric features influencing the filling capability', ASME/BATH 2015 Symposium on Fluid Power and Motion Control, Chicago, USA, 2015, doi: 10.1115/FPMC2015-9539.
- [13] M. Rundo, G. Altare, P. Casoli, 'Simulation of the filling capability in vane pumps', *Energies*, 12 (2), 2019, doi: 10.3390/en12020283.
- [14] A. Corvaglia, M. Rundo, P. Casoli, A. Lettini, 'Evaluation of Tooth Space Pressure and Incomplete Filling in External Gear Pumps by Means of Three-Dimensional CFD Simulations', *Energies*, 14 (1), 2021, doi: 10.3390/en14020342.
- [15] M. Rundo, R. Squarcini, F. Furno, 'Modelling of a Variable Displacement Lubricating Pump with Air Dissolution Dynamics', *SAE Int. J. Engines*, 11 (2), pp. 111-126, doi: 10.4271/03-11-02-0008.
- [16] U. Stuppioni, A. Suman, M. Pinelli, A. Blum, 'Computational fluid dynamics modeling of gaseous cavitation in lubricating vane pumps: An approach based on dimensional analysis', *J. Fluids Eng.*, 142 (7), 2020, doi: 10.1115/1.40464.
- [17] M. Rundo, G. Altare, 'Lumped Parameter and Three-Dimensional Computational Fluid Dynamics Simulation of a Variable Displacement Vane Pump for Engine Lubrication', *J. Fluids Eng.*, 140(6), 2018, doi: 10.1115/1.4038761.
- [18] G. Altare, M. Rundo, 'Advances in simulation of gerotor pumps: An integrated approach', *Proc. ImechE, Part C: J. Mech. Eng. Sci.*, 231 (7), pp. 1221-1236, 2017, doi: 10.1177/0954406217694663.

Biographies



Alessandro Corvaglia received his MSc degree in Mechanical Engineering (2016) from the Politecnico di Torino. After graduation, he joined the Fluid Power Research Laboratory of Politecnico di Torino as Research Fellow developing simulation models for axial piston and external gear pumps. In 2018 he started his PhD in Energetics focusing on the advanced modeling of lubricated gaps in axial piston pumps.



Massimo Rundo received his MSc degree in mechanical engineering from the Politecnico di Torino, Italy, in 1996. After graduation, he worked as a visiting researcher, and later as a research fellow, at the Fluid Power Research Laboratory of the Politecnico di Torino, contributing to extensive research projects on positive displacement pumps. In 2005 he joined the faculty at the Department of Energy as assistant professor. He is currently an associate professor of fluid power. His research activity is primarily focused on modelling, simulation and testing of fluid power components and systems.



Sara Bonati received her MSc degree in mechanical engineering from the University of Parma in 2016. At the same university, she carried out a research grant in 2016 in partnership with Fornovo Gas S.r.l concerning the development of lumped-parameter fluid dynamics models of positive displacement compressors. She has been working at Casappa Spa since 2017 in the R&D team as Simulation Engineer, focusing on research and product development activities through CAE tools.



Manuel Rigosi completed his MSc degree in Mechanical Engineering from the University of Parma, in 2011. After an internship, he joined Casappa R&D Department in the role of

Simulation Engineer, focused in replicating the physical phenomena within hydraulic gear and piston pumps through the usage of customized lumped parameter models and 3D simulations. In 2018 he took the responsibility for the development of new products with a team of engineers and designers. In recent years he has contributed to innovation by signing 4 patents regarding solutions already applied to the latest products Casappa is offering on the market today.