

---

# Comparative Analysis of Positive Buck Boost Converter with PID and Fuzzy Logic Controller

---

Piyush Singh<sup>1,\*</sup>, P. Parthiban<sup>1</sup>, R. Kalpana<sup>1</sup>, S.Rambabu<sup>2</sup>, M.Vijaya<sup>2</sup>

<sup>1</sup>*Department of Electrical & Electronics Engineering – National institute of technology  
Karnataka, surathkal India-575025*

<sup>2</sup>*NSTL Visakhapatnam India*

*\*Email id – piyushsingh210196@gmail.com*

## Abstract.

This paper presents the closed loop working and analysis of PBB converter. Implementation of closed loop is performed with both PID and Fuzzy logic controller separately, the results are verified with simulations. Obtained performances are further compared on the basis of settling time, overshoots & Output deviations. It requires small signal analysis done by small signal linearization or state space averaging method. Both gives the similar transfer function of converter after which compensator is designed for obtaining the desired output. Instead of modelling, FLC is implemented according to system behaviour.

**Keywords.** Positive buck boost (PBB), fuzzy logic controller (FLC), state space averaging, small signal modelling, right half plane (RHP), pulse width modulation (PWM), proportional–integral–derivative controller (PID)

## 1. INTRODUCTION

There's a major difference between the textbook's simple inverting buck-boost converter, which produces a negative output voltage, and real-world buck-boost applications, which requires a positive output voltage, when it comes to buck-boost converter design. Thus, the PBB converter topology as shown in Figure 2.1 is used to obtain the positive output voltage, which is nothing more than the cascading of buck and boost converters, which by default produces positive output voltage and can also be used as a Bi-directional converter with minor changes, which is widely used in the renewable energy sector [1] and in electric vehicle (EVs) [2] applications. SEPIC, Zeta and Flyback topologies also have positive output voltage but are avoided because of their complexity in structure, RHP zero and fourth-order system, which makes closed loop control techniques challenging. In this paper our aim is to achieve smooth transition from one mode to another mode automatically when input supply is varying between below and above the reference output voltage.

This paper is divided into five sections, the second section discusses the working analysis of PBB converter, third section describes about closed loop operation with single PID controller and fuzzy logic controller, the fourth section presents simulation results with discussions, which is followed by conclusion in the fifth section.

## 2. POSITIVE BUCK BOOST CONVERTER WORKING

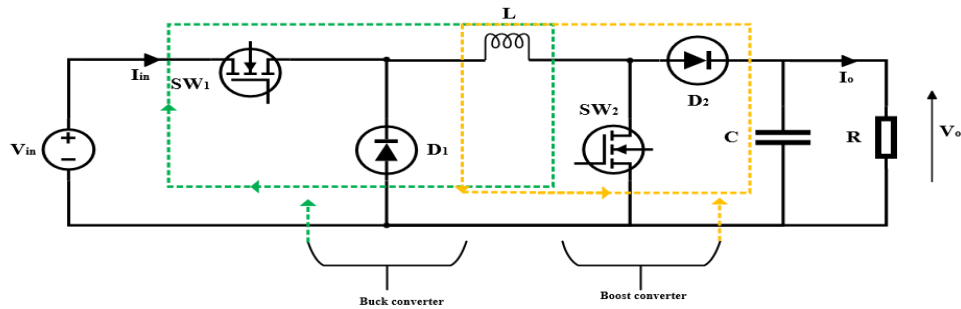

Figure 2.1 Positive buck boost converter

### 2.1. Buck mode

In this mode switch ( $sw_1$ ) is given controlled PWM and ( $sw_2$ ) is kept open as shown in Figure 2.2 thus behaving exactly as conventional buck converter and both charging and discharging mode is performed according to given duty cycle to ( $sw_1$ ). When input voltage is same as reference output voltage switch ( $sw_1$ ) is continuously ON. [3]

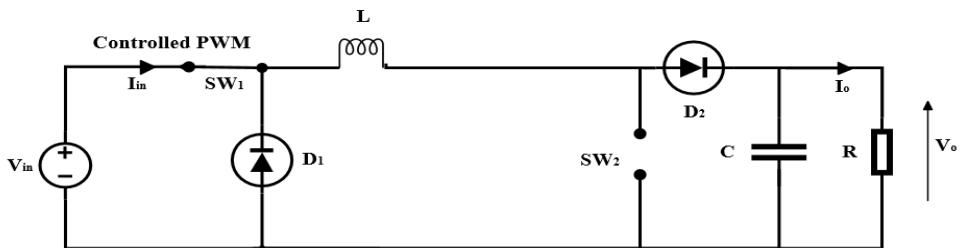

Figure 2.2 Buck mode

### 2.2. Boost mode

In this mode switch ( $sw_1$ ) is continuously ON to provide path for the circuit and ( $sw_2$ ) is given controlled PWM to make boost mode operation successful as shown in the Figure 2.3. Thus it can be operated as standalone boost converter with all conventional equations valid.

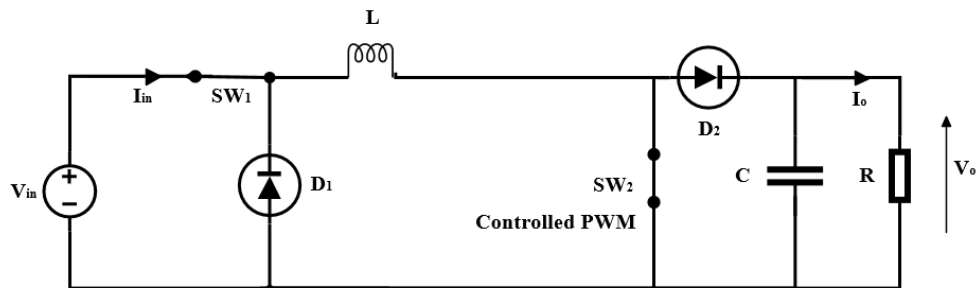

Figure 2.3 Boost mode

### 2.3. Buck-boost mode

In this mode of operation both the switches are given controlled PWM so that it performs both buck and the boost operations simultaneously without inverting the output voltage and giving positive output voltage as depicted in Figure 2.4. The issue with this mode of operation is that both the switches ( $sw_1$ ) and ( $sw_2$ ) are operating at the same time which will create high turn- on and turn-off losses. Also these losses would be high as power ratings and switching frequency of the converter is increased so this mode of operation is avoided. Instead separate buck and boost mode is performed when buck-boost operation is required.

Although controlling of both the switches for separate modes in PBB converter makes it challenging as compared to conventional buck-boost converter where only one switch needs to be controlled for closed loop operation. But due its certain advantages it is used over conventional converter according to applications.

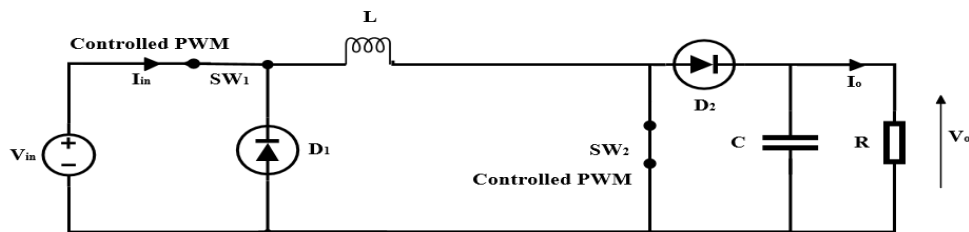

Figure 2.4 Buck boost mode

### 2.4. Selection of inductor

Since PBB converter is capable of operating in different modes, selection and design of inductor value is very crucial and it should works in continuous conduction for all the modes. Equations 2.1 & 2.2 are used for inductor calculation as shown below. [4] [5]

#### Boost inductor

$$L > \frac{V_{in,min}^2 * (V_o - V_{in,min})}{f_{sw} * 0.3 * I_o * V_o^2} \quad 2.1$$

#### Buck inductor

$$L > \frac{V_o * (V_{in,max} - V_o)}{0.3 * f_{sw} * V_{in,max} * I_o} \quad 2.2$$

Where  $f_{sw}$  is switching frequency of MOSFET

From above two equations the higher inductor value obtained is chosen so that it satisfies working in all the modes. In practice slight variations are acceptable from ideal calculations.

**Table 1 Switching pattern of MOSFETs**

Modes	Switch (sw <sub>1</sub> )	Switch (sw <sub>2</sub> )
Buck	PWM	Always off
Boost	Always on	PWM
Buck-boost	PWM	PWM

### 3. CONTROL METHODS OF CONVERTER

#### 3.1. PID controller

To obtain the desired output values with stability in close loop operation the feedback path needs to be designed and in this case PID controller is used. For tuning of controller, transfer function of converter is needed which is obtained by small signal modelling. The converter can be switched between two states: ON and OFF. During turn-on, the State Space representation can be written as given in equations 3.1 to 3.4 and shown in Figure 3.1. [6]

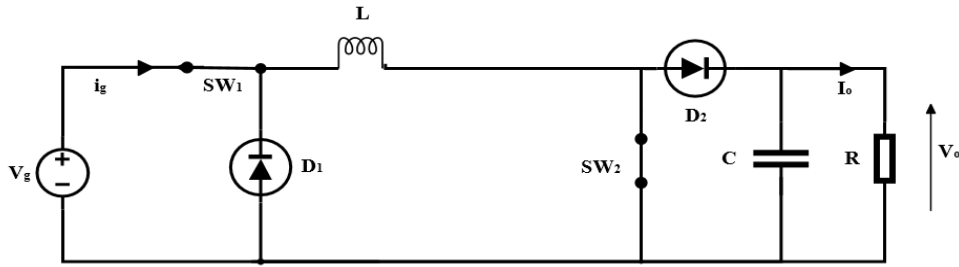

Figure 3.1 During turn on mode

$$\frac{dx(t)}{dt} = A_1x(t) + B_1u(t) \quad 3.1$$

$$y(t) = C_1x(t) + D_1u(t) \quad 3.2$$

From equations 3.1 and Figure 3.1, obtained relations are shown below

$$\begin{bmatrix} \frac{di(t)}{dt} \\ \frac{dv(t)}{dt} \end{bmatrix} = \begin{bmatrix} -R_{on}/L & 0 \\ 0 & -1/RC \end{bmatrix} \begin{bmatrix} i(t) \\ v(t) \end{bmatrix} + \begin{bmatrix} 1 & 0 \\ 0 & 0 \end{bmatrix} \begin{bmatrix} V_g \\ V_D \end{bmatrix} \quad 3.3$$

$$[i_g] = [1 \quad 0] \begin{bmatrix} i(t) \\ v(t) \end{bmatrix} + [0 \quad 0] \begin{bmatrix} V_g \\ V_D \end{bmatrix} \quad 3.4$$

$$\frac{dx(t)}{dt} = A_2x(t) + B_2u(t) \quad 3.5$$

$$y(t) = C_2x(t) + D_2u(t) \quad 3.6$$

From equation 3.5 and Figure 3.2 during turn-off of both switches equations 3.7 & 3.8 are obtained.

$$\begin{bmatrix} \frac{di(t)}{dt} \\ \frac{dv(t)}{dt} \end{bmatrix} = \begin{bmatrix} 0 & 1/L \\ -1/C & -1/RC \end{bmatrix} \begin{bmatrix} i(t) \\ v(t) \end{bmatrix} + \begin{bmatrix} 0 & -1 \\ 0 & 0 \end{bmatrix} \begin{bmatrix} V_g \\ V_D \end{bmatrix} \quad 3.7$$

$$[i_g] = [0 \quad 0] \begin{bmatrix} i(t) \\ v(t) \end{bmatrix} + [0 \quad 0] \begin{bmatrix} V_g \\ V_D \end{bmatrix} \quad 3.8$$

The small signal model obtained is shown in Figure 3.3 and transfer function derived is given below in equation 3.9. It has a RHP zero making it unstable and difficult to control. Thus proper compensator is required for desired performance and stable operation.

$$G_{vd} = \frac{V_{out}}{DD'} \left\{ \frac{\left(1 - \frac{s}{D'^2 V_{out}/DLI_0}\right)}{1 + \frac{s}{D'^2 R/L} + \frac{s^2}{D'^2/LC}} \right\} \quad 3.9$$

Where  $D' = 1 - D$

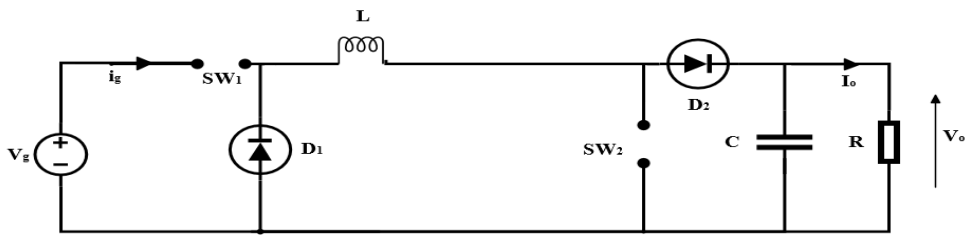

Figure 3.2 During turn off mode

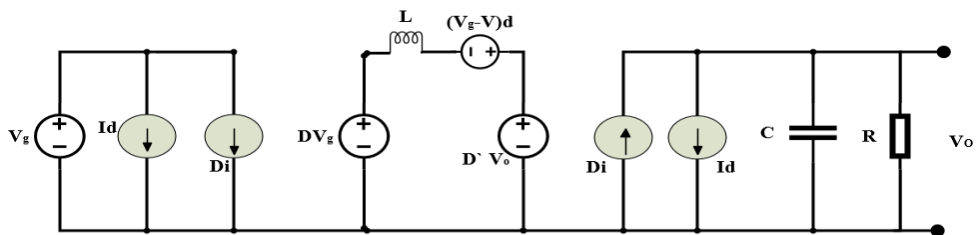

Figure 3.3 Small signal model

### 3.2. Fuzzy logic controller (FLC)

The fuzzy logic controller is a heuristic approach that relies on human expertise rather than being an expert system in and of itself. Fuzzification, Rule base and Defuzzification are the three steps. This sort of controller is commonly employed in non-linear systems and is now gaining popularity in the renewable energy sector with proper knowledge and working of system. This controller can be designed without requiring any mathematical

relations which brings it in huge demand. The major portion of the controller is the rule base block, which generates fuzzy rules between input and output. There is two input to FLC error  $e(x)$  and change in error  $\Delta e(x)$  and output is duty cycle  $d(x)$  as shown in equations 3.10 to 3.12. The rule base for all 2<sup>nd</sup> order converter is as follows. “If the ERROR in the output voltage is a BIG POSITIVE quantity & the CHANGE IN ERROR is a BIG POSITIVE quantity, the DUTY CYCLE must be reduced by a large amount, resulting in a BIG NEGATIVE perturbation in the duty cycle.” Table 2 shows the fuzzy logic rules [7]

$$e(x) = v_o - v_{ref} \quad 3.10$$

$$\Delta e(x) = e(x) - e(x - 1) \quad 3.11$$

$$d(x) = d(x - 1) + \Delta d \quad 3.12$$

**Table 2 Fuzzy Logic Rules**

Error / $\Delta$ Error	NB	NS	ZE	PS	PB
NB	PB	PB	PB	PS	PS
NS	PB	PS	PS	PS	ZE
ZE	PS	PS	ZE	NS	NS
PS	ZE	NS	NS	NS	NB
PB	NS	NB	NB	NB	NB

#### 4. SIMULATION RESULT AND DISCUSSIONS

Simulation results of both the control techniques are shown below one by one where the input voltage is varying between (250-600) volts as shown in Figure 4.2. Closed loop operation is achieved to obtain constant output voltage of 300 v with constant load.

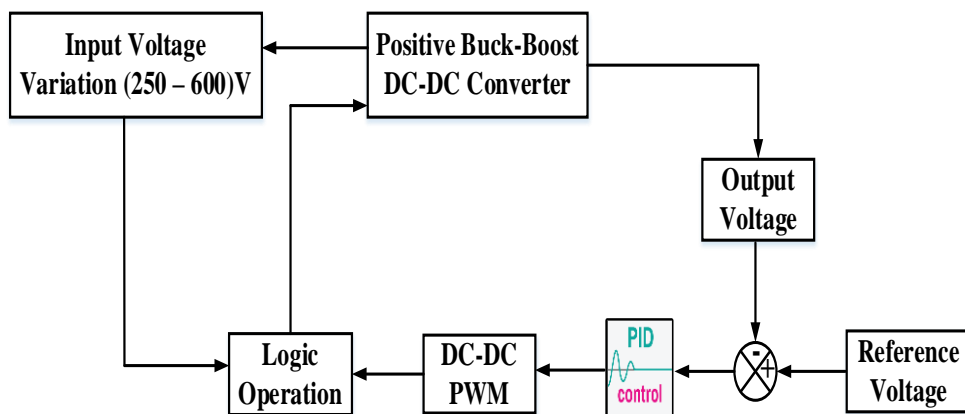

Figure 4.1 Block diagram of Closed loop PBB converter with PID controller

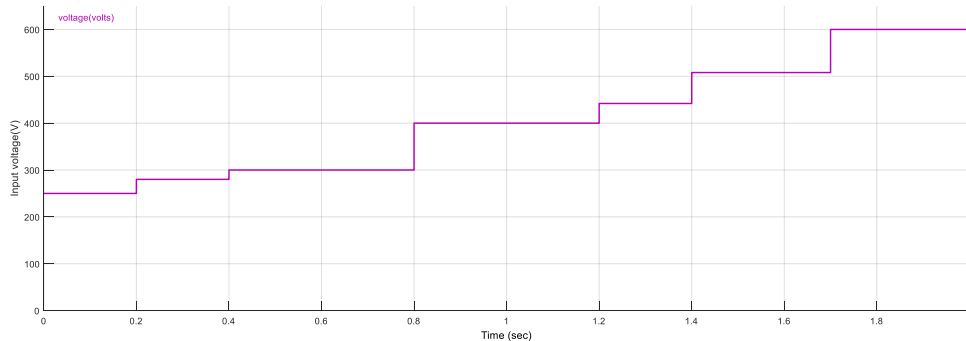

Figure 4.2 Input voltage

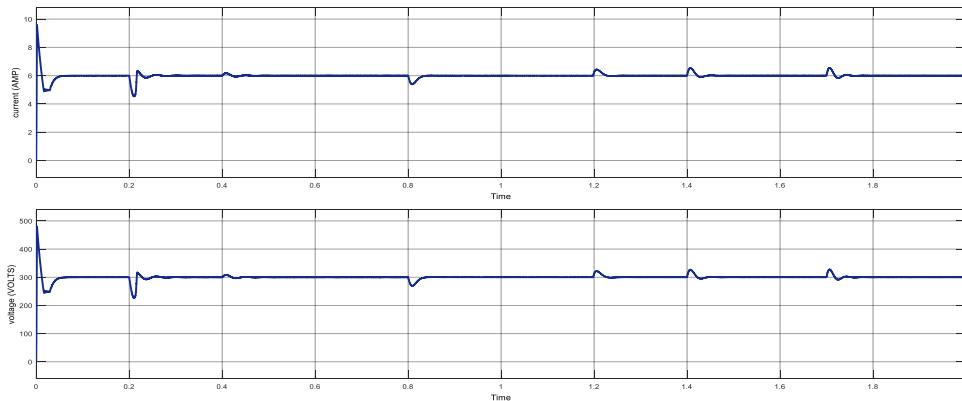

Figure 4.3 Output current & voltage with PID controller

A combination of logic gates are used for mode selection of converter as shown in Figure 4.1. Whenever input voltage variation occurs below and above reference voltage automatically there is smooth transition from buck mode to boost and vice-versa. Here design of controller value is of importance it should be such that it works for all the modes instead of working for just single mode. “Type-3 compensator” [8] is also suggested in literature to obtain desired results. From (250- 300) volts the circuit is working as boost converter to step up the voltage to 300 volts and for rest from (300-600) volts it works as buck converter to step down the voltage. The constant output voltage of 300 volts is obtained & transient conditions are as shown in Figure 4.3.

In FLC, the sensed output is compared with given desired reference and error is generated. It is good practice to keep membership function values in the range of [-1 to 1] and other segments (NB,NS,ZE,PS,PB) is scaled accordingly. The error obtained is multiplied with some constant gain factor and used as one input to fuzzy controller the other input of which is change in error as mentioned in Figure 4.4. The working of FLC is according to the rules we provided the output of which is scaled by some gain factor. The obtained result is given as duty cycle to the gate of MOSFETs. Tuning of gain values of various blocks is a sensitive work and needs to be done carefully. Setting up of wrong values may outperform the controller despite of correct logic used in fuzzy rule base. As in previous section for smooth buck to boost mode transition combination of logic gates is used instead of that fuzzy logic based switch can also be implemented. [9] According to the requirements, fuzzy sets can be 3 or 7, resulting in 9 or 49 control rules. The complexity of

the system will increase as additional fuzzy sets are added, although efficiency may improve. The major function of a fuzzy logic controller is to provide a rule basis, and this is accomplished by analysing the behaviour of the system rather than modelling it, which makes it attractive in the renewable energy industry. Because modelling of any system is a challenging endeavour.

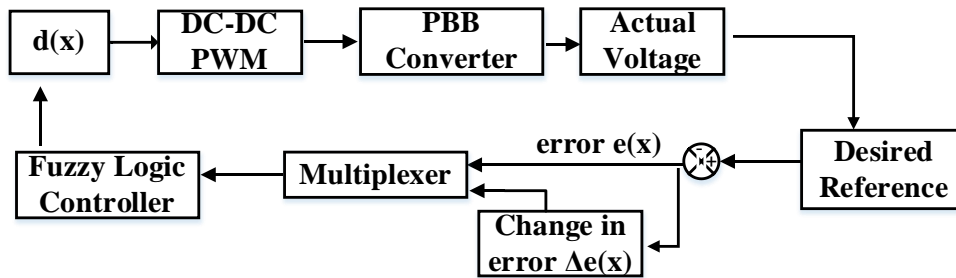

Figure 4.4 Block diagram of Closed loop PBB converter with FLC controller

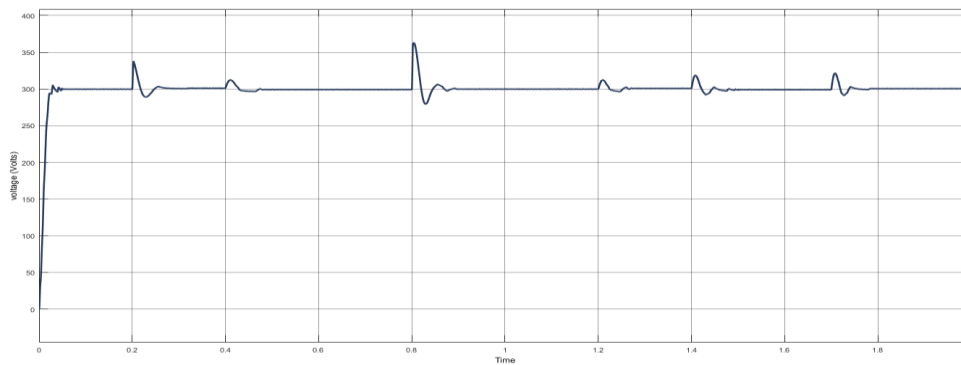

Figure 4.5 Output voltage of PBB with FLC

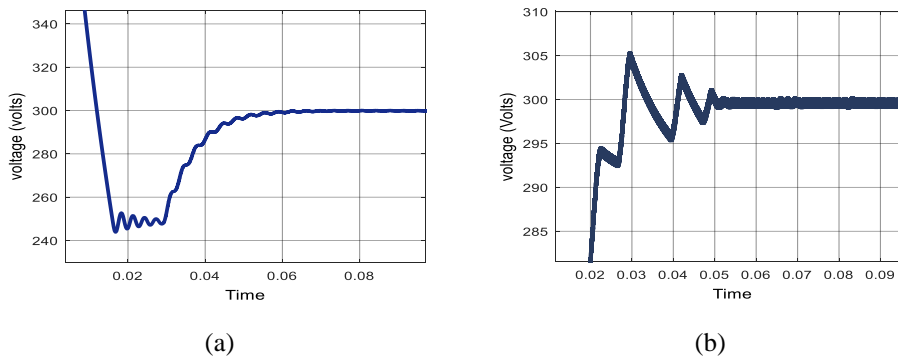

Figure 4.6 Initial transients with different controllers (a) PID (b) FLC



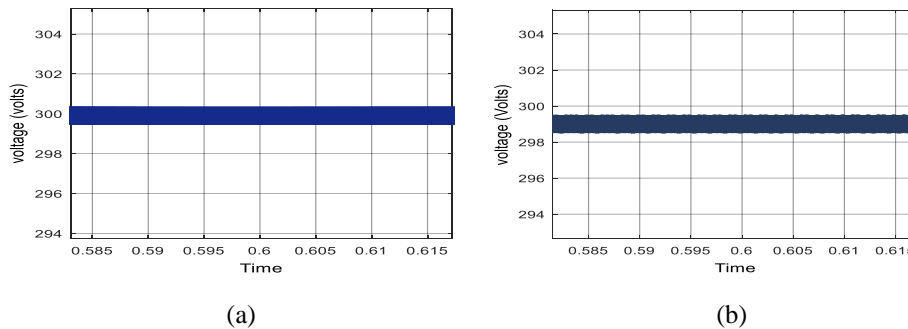

Figure 4.7 Output voltage deviations (a) PID (b) FLC

## CONCLUSION

For same circuit parameters and input variations the initial transients in PID is much higher as compared to FLC as shown in Figures 4.6. During every input variation the overshoots & undershoots are much higher in FLC as compared to PID shown in Figure 4.5. FLC is taking more settling time compared to PID to achieve desired output also the later one achieves perfect output whereas FLC shows slight variations of (1-2) volts as shown in Figure 4.7. Also with extensively performed simulations it is verified that FLC alone can't be implemented for smooth transitioning between separate modes of operation of converter whereas it can easily be done with proper tuned PID controller. It can be operated in all the three modes independently that is buck, boost & buck-boost. If implementing single FLC in PBB then it can only be implemented in third mode buck-boost mode when same duty cycle is given to both the switches at the same time. But this mode is avoided in PBB converter working as losses are increased due to both switches working at a time and most important the beauty of this converter for operating independently in all the three modes is lost.

## 5. REFERENCES

- [1] Y. S. Joel, . H. V. Saikumar and S. S. R. Patange, "Design & performance analysis of Fuzzy based MPPT control using two-switch non inverting Buck-Boost converter," in *International Conference on Electrical Power and Energy Systems (ICEPES)*(pp. 414-419), 2016.
- [2] A. Hajizadeh, "Fuzzy/StatFeedback Control of a Non-Inverting Buck-Boost Converter for Fuel Cell Electric Vehicles," *Iranica Journal of Energy & Environment*, vol. 5, no. 1, pp. 34-41, 2014.
- [3] V. Viswanatha and R. V. S. Reddy, "Modeling, simulation and analysis of noninverting buck-boost converter using PSIM," in *International Conference on Circuits, Controls, Communications and Computing (I4C)*, (pp. 1-5), 2016.
- [4] V. Choudhary, . T. Hegarty and D. Pace, "Under the hood of a noninverting buck-boost converter," Power Supply Design Seminar, Texas Instruments, Rep. SLUP346, (2016).
- [5] J. Hagedorn, "Basic calculations of a 4 switch buck-boost power stage," Texas Instruments, Rep. SLVA535B, Dallas, Texas, USA, (2018).

- [6] . R. W. Erickson and D. Maksimovic, Fundamentals of power electronics, Springer Science & Business Media, 2007.
- [7] . S. K. Gadari, P. Kumar, K. Mishra, A. R. Bhowmik and A. K. Chakraborty, “Detailed analysis of Fuzzy Logic Controller for Second order DC-DC Converters,” in *8th International Conference on Power Systems (ICPS)* (pp. 1-6). *IEEE.*, (2019, December).
- [8] . A. K. Chauhan, . V. R. Vakacharla, A. K. Verma and S. K. Singh, “Multiple PMSG fed Non-inverting buck-boost converter for HEVs,” in *IEEE 6th International Conference on Power Systems (ICPS)* (pp. 1-6). *IEEE.*, (2016).
- [9] O. N. Almasi, V. Fereshtehpoor, M. H. Khooban and . F. Blaabjerg, “Analysis, control and design of a non-inverting buck-boost converter: A bump-less two-level T–S fuzzy PI control,” *ISA transactions*, vol. 67, pp. 515-527, (2017).

## Biographies

**Piyush Singh** received his B.Tech in Electrical Engineering from Kamla Nehru Institute of Technology (KNIT), Sultanpur, India in the year 2019. Currently, He is working towards M.Tech (Research) degree in Power & Energy Systems, Department of Electrical & Electronics Engineering from National Institute of Technology Karnataka (NITK) Surathkal, India. His research interests are Power Electronics in EV applications, DC-DC Converter topologies and their control techniques.

**P.Partiban** Currently, He is working as Associate Professor in Department of Electrical & Electronics Engineering National Institute of Technology Karnataka (NITK) Surathkal, India. His research area includes Power Electronics & Drives.

**R. Kalpana** Currently, She is working as Assistant Professor in Department of Electrical & Electronics Engineering National Institute of Technology Karnataka (NITK) Surathkal, India. Her research area includes Power Electronics & Drives.

**S.Rambabu** is working as scientist in NSTL Visakhapatnam. His research area includes Power Electronics & Drives.

**M.Vijaya** is working as scientist in NSTL Visakhapatnam. His research area includes Power Electronics & Drives.